









D Trockensprinkler

F Sprinkleurs Dry

 DS-1	<p>Standard Coverage, Pendent Standard Sprühbereich, Hängend Protection Standard, Pendant</p>	<p>P. 1.059</p>
 DS-SS316	<p>Standard Coverage, Pendent, Stainless Steel Standard Sprühbereich, Hängend, Edelstahl Protection Standard, Pendant, Inox</p>	<p>P. 1.060</p>
 HTS-15	<p>Standard Coverage, Pendent Standard Sprühbereich, Hängend Protection Standard, Pendant</p>	<p>P. 1.061</p>
 DS-1	<p>Standard Coverage, Upright Standard Sprühbereich, Stehend Protection Standard, Debout</p>	<p>P. 1.062</p>
 DS-1	<p>Standard Coverage, Horizontal Sidewall Standard Sprühbereich, Horizontal Seitenwand Protection Standard, Horizontal Mural</p>	<p>P. 1.063</p>
 DS-2	<p>Standard Coverage, Pendent Standard Sprühbereich, Hängend Protection Standard, Pendant</p>	<p>P. 1.064</p>
 DS-2	<p>Extended Coverage, Pendent Mit erweitertem Sprühbereich, Hängend Couverture Etendue, Pendant</p>	<p>P. 1.065</p>
 DS-ECC	<p>Quick Response, Extended Coverage, Pendent Consealed Schnell Ansprechend, Erweitertem Sprühbereich, Hängend Verdeckt Réponse Rapide, Couverture Etendue, Pendant Caché</p>	<p>P. 1.066</p>

Dry Sprinklers, Standard Coverage, Pendent

D Trockensprinkler, Standard Sprühbereich, Hängend

F Sprinkleurs Dry, Protection Standard, Pendent

1



TFP 500/510 [Quick Response/Schnell Ansprechend/Réponse Rapide]



Art. Nr. 568504001, W-Type 7

[P.1.117]

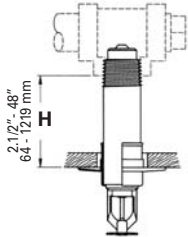

Type 1

Standard Escutcheon
Standard Rosette
Rosace Standard

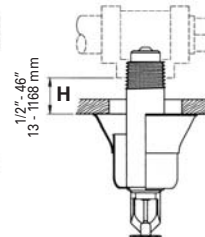

Type 2

Deep Escutcheon
Tiefe Rosette
Rosace Profonde

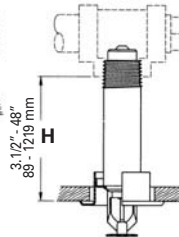

Type 3

Recessed Escutcheon
Versenkte Rosette
Rosace Encastrée

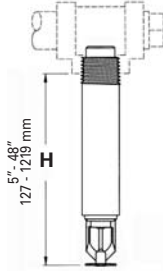

Type 4

w/o Escutcheon
ohne Rosette
sans Rosace

K=80 [5.6] • 1" ISO • SINTY3255 • UL/FM/CNBOP • CE

ART. NR. I60 XX X X XXX

Standard Response/ Standard Ansprechend/Réponse Standard		Temp. °C [°F]		Sprinkler/ Sprinkler/Sprinkleur		F Escutcheon/ Rosette/Rosace		H* mm ["]	
96	Type 1	0	57 [135]	1	Brass/Rotguß/Laiton	White/Weiß/Blanc	060	152 [6.00]	
93	Type 2	1	68 [155]	4	White/Weiß/Blanc	White/Weiß/Blanc	062	159 [6.25]	
97	Type 3	2	79 [175]	9	Chrome/Chrom/Chromé	Chrome/Chrom/Chromé	065	165 [6.50]	
92	Type 4	3	93 [200]	0	Chrome/Chrom/Chromé	White/Weiß/Blanc	067	171 [6.75]	
		4	141 [286]**				372	946 [37.25]	
		5	182 [360]**				480	1219 [48.00]	

**Not available for type 3
** Nicht Verfügbar für Typ 3
** Non disponible pour type 3

* Available in Pendent, Upright and Conventional
* Erhältlich in hängend, stehend und konventionell
* Disponible en modèle pendent, debout et conventionnel

K=80 [5.6] • 1" ISO • SINTY3235 • UL/FM

ART. NR. I60 XX X X XXX

Quick Response/ Schnell Ansprechend/Réponse Rapide		Temp. °C [°F]		Sprinkler/ Sprinkler/Sprinkleur		F Escutcheon/ Rosette/Rosace		H* mm ["]	
36	Type 1	0	57 [135]	1	Brass/Rotguß/Laiton	White/Weiß/Blanc	060	152 [6.00]	
33	Type 2	1	68 [155]	4	White/Weiß/Blanc	White/Weiß/Blanc	062	159 [6.25]	
37	Type 3	2	79 [175]	9	Chrome/Chrom/Chromé	Chrome/Chrom/Chromé	065	165 [6.50]	
32	Type 4	3	93 [200]	0	Chrome/Chrom/Chromé	White/Weiß/Blanc	067	171 [6.75]	
		4	141 [286]				372	946 [37.25]	
		5	182 [360]				480	1219 [48.00]	

*Order length in 6 mm [1/4"] increments
*Bestellängen in 6 mm [1/4"] Abständen
*Longueur par incréments de 6 mm [1/4"]

TYCEGFFP-12/06 Tyco reserves the right to change the contents without notice

- D** Trockensprinkler, Standard Sprühbereich, Hängend
- F** Sprinkleurs Dry, Protection Standard, Pendant Inox

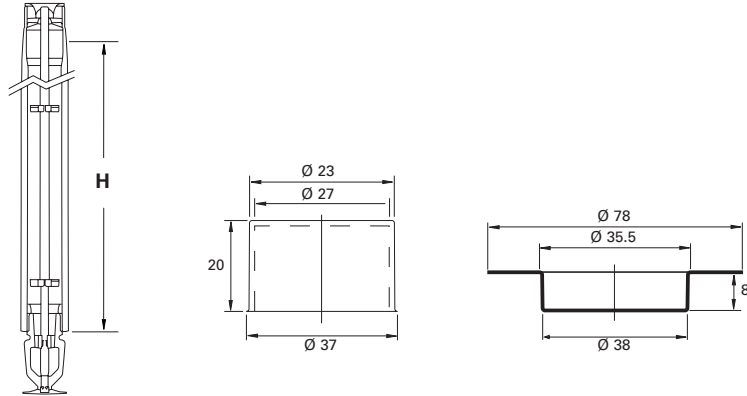

K=80 [5.6] • 1" ISO
ART. NR. A531 X X X XXX

Escutcheon/ Rosette/ Rosace		Connection/ Anschluß/ Connection		Temperature/ Temperatur/ Température		Length mm/ Länge mm/ Longueur mm	
A	No escutcheon/keine Rosette/sans rosace	M	SS316 unthreaded end 18 mm SS316 ohne Gewinde 18 mm Inox SS316 embout lisse 18 mm	A	57° C	050	Min./Min./Mini
B	With 2-piece escutcheon SS304 Mit 2-teilige Rosette Avec rosace 2 pièces en Inox SS304	R	SS316 unthreaded end 10 mm SS316 ohne Gewinde 10 mm Inox SS316 embout lisse 10 mm	B	68° C	999	Max./Max./Maxi
				D	79° C		
				E	93° C		
				G	141° C		
				C	182° C		

TYCEGFFP-12/06 Tyco reserves the right to change the contents without notice

D Trockensprinkler, Standard Sprühbereich, Hängend

F Sprinkleurs Dry, Protection Standard, Pendent

1



Art. Nr. 568504001, W-Type 7

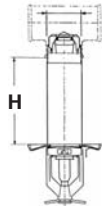

HTS15

K=80 [5.6] • 1" ISO

Art. Nr. Standard Standard Standard	T °C [°F]	F	H mm	VDS	PAVUS	T/S/U
GHTSFB5100	68 [155]	9	100	√	√	√
GHTSFB5200	68 [155]	9	200	√	√	√
GHTSFB5300	68 [155]	9	300	√	√	√
GHTSFB5400	68 [155]	9	400	√	√	√
GHTSFB5500	68 [155]	9	500	√	√	√



HTS15 ESCUTCHEON

Art. Nr.	Description / Umschreibung / Description
2145386	White Escutcheon HTS15/Weisse Rosette HTS15/Rosace blanche

Dry Sprinklers, Standard Coverage, Upright

D Trockensprinkler, Standard Sprühbereich, Stehend

F Sprinkleurs Dry, Protection Standard, Debout



TFP 500/510 [Quick Response/Schnell Ansprechend/Réponse Rapide]



Art. Nr. 568504001, W-Type 7

[P.1.117]

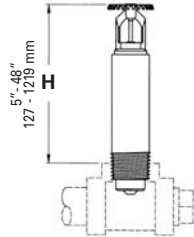

K=80 [5.6] • 1" ISO • SINTY3155 • UL/FM • CE

ART. NR. I60 XX X X XXX

Standard Response/ Standard Ansprechend/Réponse Standard		Temp. °C [°F]		Sprinkler/ Sprinkler/Sprinkleur		F Escutcheon/ Rosette/Rosace		H* mm ["]	
98	Upright/Stehend/Debout	0	57 [135]	1	Brass/Rotguß/Laiton	White/Weiß/Blanc	060	152 [6.00]	
		1	68 [155]	4	White/Weiß/Blanc	White/Weiß/Blanc	062	159 [6.25]	
		2	79 [175]	9	Chrome/Chrom/Chromé	Chrome/Chrom/Chromé	065	165 [6.50]	
		3	93 [200]	0	Chrome/Chrom/Chromé	White/Weiß/Blanc	067	171 [6.75]	
		4	141 [286]				372	946 [37.25]	
		5	182 [360]				480	1219 [48.00]	

K=80 [5.6] • 1" ISO • SINTY3135 • UL/FM

ART. NR. I60 XX X X XXX

Quick Response/ Schnell Ansprechend/Réponse Rapide		Temp. °C [°F]		Sprinkler/ Sprinkler/Sprinkleur		F Escutcheon/ Rosette/Rosace		H* mm ["]	
38	Upright/Stehend/Debout	0	57 [135]	1	Brass/Rotguß/Laiton	White/Weiß/Blanc	060	152 [6.00]	
		1	68 [155]	4	White/Weiß/Blanc	White/Weiß/Blanc	062	159 [6.25]	
		2	79 [175]	9	Chrome/Chrom/Chromé	Chrome/Chrom/Chromé	065	165 [6.50]	
		3	93 [200]	0	Chrome/Chrom/Chromé	White/Weiß/Blanc	067	171 [6.75]	
		4	141 [286]				372	946 [37.25]	
		5	182 [360]				480	1219 [48.00]	

*Order length in 6 mm [1/4"] increments
*Bestellängen in 6 mm [1/4"] Abständen
*Longueur par incréments de 6 mm [1/4"]

TYCEGFFP-12/06 Tyco reserves the right to change the contents without notice

Dry Sprinklers, Standard Coverage, Horizontal Sidewall

D Trockensprinkler, Standard Sprühbereich, Horizontal Seitenwand

F Sprinkleurs Dry, Protection Standard, Horizontal Mural

1



DS-1



TFP 500/510 [Quick Response/Schnell Ansprechend/Réponse Rapide]



Art. Nr. 568504001, W-Type 7

[P.1.117]

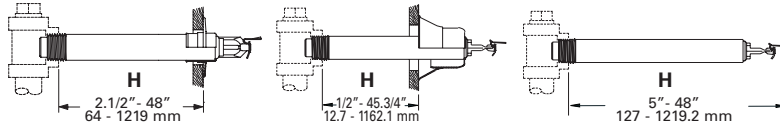

Type 1

Extended Escutcheon
Tiefe Rosette
Rosace Rallongée

Type 2

Deep Escutcheon
Tiefe Rosette
Rosace Profonde

Type 3

w/o Escutcheon
ohne Rosette
sans Rallongée

K=80 [5.6] • 1" ISO • SINTY3355 • UL/FM • CE

ART. NR. I60 XX X X XXX

	Standard Response/ Standard Ansprechend/Réponse Standard	Temp. °C [°F]	Sprinkler/ Sprinkler/Sprinkleur		Escutcheon/ Rosette/Rosace	H*		
			F			mm	["]	
94	Horizontal Sidewall Type 1/ Horizontal Seitenwand Typ 1/Horizontal Mural Type 1	0	57 [135]	1	Brass/Rotguß/Laiton	White/Weiß/Blanc	060	152 [6.00]
		1	68 [155]	4	White/Weiß/Blanc	White/Weiß/Blanc	062	159 [6.25]
53	Horizontal Sidewall Type 2/ Horizontal Seitenwand Typ 2/Horizontal Mural Type 2	2	79 [175]	9	Chrome/Chrom/Chromé	Chrome/Chrom/Chromé	065	165 [6.50]
		3	93 [200]	0	Chrome/Chrom/Chromé	White/Weiß/Blanc	067	171 [6.75]
54	Horizontal Sidewall Type 3/ Horizontal Seitenwand Typ 3/Horizontal Mural Type 3	4	141 [286]				372	946 [37.25]
		5	182 [360]				480	1219 [48.00]

K=80 [5.6] • 1" ISO • SINTY3335 • UL/FM

ART. NR. I60 XX X X XXX

	Quick Response/ Schnell Ansprechend/Réponse Rapide	Temp. °C [°F]	Sprinkler/ Sprinkler/Sprinkleurs		Escutcheon/ Rosette/Rosace	H*		
			F			mm	["]	
34	Horizontal Sidewall Type 1/ Horizontal Seitenwand Typ 1/Horizontal Mural Type 1	0	57 [135]	1	Brass/Rotguß/Laiton	White/Weiß/Blanc	060	152 [6.00]
		1	68 [155]	4	White/Weiß/Blanc	White/Weiß/Blanc	062	159 [6.25]
43	Horizontal Sidewall Type 2/ Horizontal Seitenwand Typ 2/Horizontal Mural Type 2	2	79 [175]	9	Chrome/Chrom/Chromé	Chrome/Chrom/Chromé	065	165 [6.50]
		3	93 [200]	0	Chrome/Chrom/Chromé	White/Weiß/Blanc	067	171 [6.75]
44	Horizontal Sidewall Type 3/ Horizontal Seitenwand Typ 3/Horizontal Mural Type 3	4	141 [286]				372	946 [37.25]
		5	182 [360]				480	1219 [48.00]

*Order length in 6 mm [1/4"] increments
*Bestellängen in 6 mm [1/4"] Abständen
*Longueur par incréments de 6 mm [1/4"]

TYCEGFFP-12/06 Tyco reserves the right to change the contents without notice

Dry Sprinklers, Standard Coverage, Pendent

- D** Trockensprinkler, Standard Sprühbereich, Hängend
- F** Sprinkleurs Dry, Protection standard, Pendant, Large Orifice



TFP 530
Art. Nr. 568504001, W-Type 7
 [P.1.117]

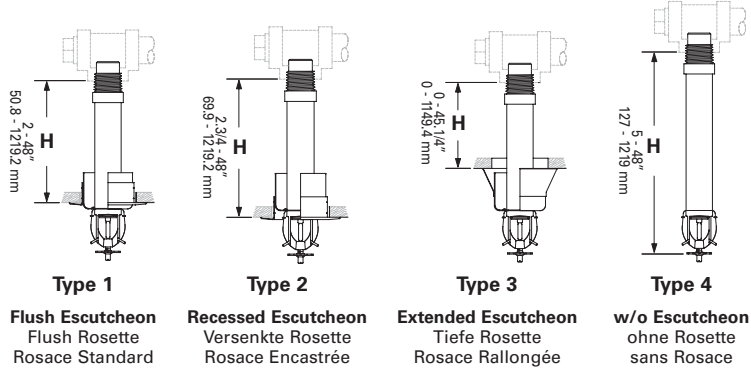

K=147-161 [10.2-11.2] • 1" ISO • SINTY5255 • UL
ART. NR. I6I XX X X XXX

	Standard Response/ Standard Ansprechend/Réponse Standard		Temp. °C [°F]		Sprinkler/ Sprinkler/Sprinkleur		F Escutcheon/ Rosette/Rosace		H* mm ["]		
	Type		0	1	1	4	9	0	5	060	062
10	Type 1		57 [135]	68 [155]	1	Brass/Rotguß/Laiton	White/Weiß/Blanc			152 [6.00]	
11	Type 2				4	White/Weiß/Blanc	White/Weiß/Blanc			159 [6.25]	
12	Type 3		79 [175]		9	Chrome/Chrom/Chromé	Chrome/Chrom/Chromé			165 [6.50]	
13	Type 4		93 [200]		0	Chrome/Chrom/Chromé	White/Weiß/Blanc			171 [6.75]	
			141 [286]		5	Brass/Rotguß/Laiton	Brass/Rotguß/Laiton			372	946 [37.25]
										480	1219 [48.00]

K=147-161 [10.2-11.2] • 1" ISO • SINTY5235 • UL/FM
ART. NR. I6I XX X X XXX

	Quick Response/ Schnell Ansprechend/Réponse Rapide		Temp. °C [°F]		Sprinkler/ Sprinkler/Sprinkleur		F Escutcheon/ Rosette/Rosace		H* mm ["]		
	Type		0	1	1	4	9	0	5	060	062
30	Type 1		57 [135]	68 [155]	1	Brass/Rotguß/Laiton	White/Weiß/Blanc			152 [6.00]	
31	Type 2				4	White/Weiß/Blanc	White/Weiß/Blanc			159 [6.25]	
32	Type 3		79 [175]		9	Chrome/Chrom/Chromé	Chrome/Chrom/Chromé			165 [6.50]	
35	Type 4		93 [200]		0	Chrome/Chrom/Chromé	White/Weiß/Blanc			171 [6.75]	
			141 [286]		5	Brass/Rotguß/Laiton	Brass/Rotguß/Laiton			372	946 [37.25]
										480	1219 [48.00]

*Order length in 6 mm [1/4"] increments
 *Bestellängen in 6 mm [1/4"] Abständen
 *Longueur par incréments de 6 mm [1/4"]

TYCEGFFP-12/06 Tyco reserves the right to change the contents without notice

Dry Sprinklers, Extended Coverage, Pendent

- D** Trockensprinkler, mit Erweitertem Sprühbereich, Hängend
- F** Sprinkleurs Dry, Couverture Etendue, Pendent, Large Orifice

1



TFP540



Art. Nr. 568504001, W-Type 7

[P.1.117]

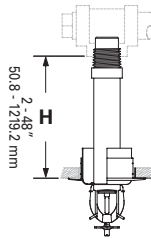

Type 1
Flush Escutcheon
Flush Rosette
Rosace standard

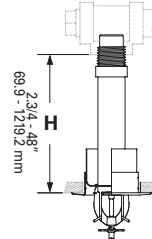

Type 2
Recessed Escutcheon
Versenkte Rosette
Rosace rallongée

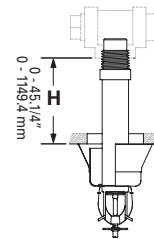

Type 3
Extended Escutcheon
Tiefe Rosette
Rosace encastrée

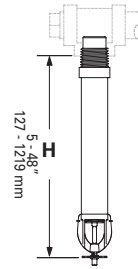

Type 4
w/o Escutcheon
ohne Rosette
sans Rosace

K=147-161 [10.2-11.2] • 1" ISO • SINTY5238 • UL

ART. NR. I6I XX X X XXX

Standard & Quick Response / Standard & Schnell Ansprechend/Standard & Réponse Rapide		Temp. °C [°F]		Sprinkler/ F Escutcheon/ Sprinkler/Sprinkleur Rosette/Rosace		H* mm ["]	
40	Type 1	0	57 [135]	1	Brass/Rotguß/Laiton	White/Weiß/Blanc	060 152 [6.00]
41	Type 2	1	68 [155]	4	White/Weiß/Blanc	White/Weiß/Blanc	062 159 [6.25]
42	Type 3	2	79 [175]	9	Chrome/Chrom/Chromé	Chrome/Chrom/Chromé	065 165 [6.50]
43	Type 4	3	93 [200]	0	Chrome/Chrom/Chromé	White/Weiß/Blanc	067 171 [6.75]
		4	141 [286]	5	Brass/Rotguß/Laiton	Brass/Rotguß/Laiton	372 946 [37.25]
							480 1219 [48.00]

*Order length in 6 mm [1/4"] increments
*Bestellängen in 6 mm [1/4"] Abständen
*Longueur par incréments de 6 mm [1/4"]

TYCEGFFP-12/06 Tyco reserves the right to change the contents without notice

D Trockensprinkler, Schnell Ansprechend, Erweitertem Sprühbereich, Hängend Verdeckt

F Sprinkleurs Dry, Réponse Rapide, Couverture Etendue, Pendant Caché

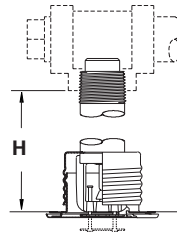

K=80 [5.6] • 1" ISO • SINTY3539 • UL

ART. NR. I 60 XX X 1 XXX

45	Quick Response / Schnell Ansprechend / Réponse Rapide	Temp. °C [°F]	H* mm ["]
	Pendent/Hängend/Pendant		
1	68 [155]	055	140 [5.50]
3	93 [200]	082	210 [8.25]
		180	457 [18.00]
		187	476 [18.75]
		372	946 [37.25]
		480	1219 [48.00]

Cover Plate/Abdeckkappe/Caché

Art. Nr.	T °C [°F]	F
567921135	57 [135]	1
567923135	57 [135]	3
677929135	57 [135]	9
567921165	74 [165]	1
567923165	74 [165]	3
567929165	74 [165]	9